

# Piston pump unit with reservoir for use in centralized lubrication systems

Product series:

KFA1-..., KFA10-..  
KFAS1-..., KFAS10-..



Owner's Manual - Containing Installation,  
Operation and Maintenance Instructions  
(Original installation instructions in accordance with EC-  
Machinery Directive 2006/42/EC)

Version 05



## WARNING:

Read this owner's manual before installing, operating or maintaining the product. Failure to follow the instructions and safety precautions in this owner's manual could result in serious injury, death, or property damage. Keep for future reference.



## Masthead

This owner's manual - containing installation, operation and maintenance instructions complies with EC-Machinery Directive 2006/42/EC and is an integral part of the described product. It must be kept for future use.

This owner's manual - containing installation, operation and maintenance instructions was created in accordance with the valid standards and regulations on documentation, VDI 4500 and EN 292.

### © SKF Lubrication Systems Germany GmbH

This documentation is protected by copyright. The photomechanical reproduction, copying, and distribution of this documentation or parts thereof by means of processes such as data processing, data carriers, and data networks is strictly prohibited without the express permission of SKF Lubrication Systems Germany GmbH .

SKF Lubrication Systems Germany GmbH reserves the right to make content and technical changes.

## Service

If you have technical questions, please contact the following offices:

### SKF Lubrication Systems Germany GmbH

Berlin Plant  
Motzener Strasse 35/37  
12277 Berlin  
Germany  
Tel. +49 (0)30 72002-0  
Fax +49 (0)30 72002-111

Hockenheim Plant  
2. Industriestrasse 4  
68766 Hockenheim  
Germany  
Tel. +49 (0)62 05 27-0  
Fax +49 (0)62 05 27-101

[lubrication-germany@skf.com](mailto:lubrication-germany@skf.com)  
[www.skf.com/lubrication](http://www.skf.com/lubrication)

# Table of contents

## Owner's Manual - Containing Installation, Operation and Maintenance Instructions

(Original installation instructions in accordance with EC-Machinery Directive 2006/42/EC)

<b>Masthead</b> .....	2	3.5.1. Modes of operation.....	14	5.3.2. Storage of electronic and electrical devices.....	31
<b>Service</b> .....	2	3.5.2. Contact time (pump cycle time).....	14	5.3.3. Storage - general information.....	31
<b>Table of contents</b> .....	3	3.5.3. Interval time.....	14	<b>6. Operation</b> .....	<b>32</b>
<b>Information concerning EC Declaration of Incorporation</b> .....	<b>4</b>	3.5.4. System monitoring.....	14	6.1. General information.....	32
<b>General information</b> .....	<b>5</b>	3.5.5. Progressive distributor monitoring ...	15	6.2. Filling the lubricant reservoir.....	32
Explanation of symbols and signs.....	5	3.5.6. Block mode.....	15	6.3. Vent centralized lubrication system.....	34
<b>1. Safety instructions</b> .....	<b>6</b>	3.5.7. Fill level monitoring.....	15	<b>7. Electronic control unit</b> .....	<b>35</b>
1.1. Intended use.....	6	3.5.8. Parameter memory.....	15	7.1. KFAS control unit (industrial and commercial vehicles).....	35
1.2. Authorized personnel.....	6	3.6. Piston pump units with progressive distributor installed.....	15	7.1.1. Display and control elements (KFAS).....	35
1.3. Electric shock hazard.....	7	<b>4. Assembly instructions</b> .....	<b>16</b>	7.1.2. Pushbutton operation (KFAS).....	36
1.4. System pressure hazard.....	7	4.1. General information.....	16	7.1.3. Programming (KFAS).....	39
1.5. Warranty and liability.....	7	4.2. Setup and attachment.....	16	7.1.4. Operation of KFAS (industrial and commercial vehicles).....	46
<b>2. Lubricants</b> .....	<b>8</b>	4.3. Connection dimensions.....	17	7.1.5. KFAS fault indications.....	49
2.1. General information.....	8	4.4. Electrical connection.....	18	<b>8. Shutdown</b> .....	<b>50</b>
2.2. Selection of lubricants.....	8	4.4.1. Electric motor connection.....	18	8.1. Temporary shutdown.....	50
2.3. Approved lubricants.....	9	4.4.2. KFA1, KFA1-W (commercial vehicles).....	19	8.2. Permanent shutdown.....	50
2.4. Lubricants and the environment.....	9	4.4.3. KFAS1, KFAS1-W (commercial vehicles).....	20	<b>9. Maintenance</b> .....	<b>51</b>
2.5. Lubricant hazards.....	9	4.4.4. KFA1-M, KFA1-M-W (industrial).....	21	9.1. General notes.....	51
<b>3. Design and function</b> .....	<b>10</b>	4.4.5. KFAS1-M, KFAS1-M-W, KFAS1-M-Z, KFAS1-M-W-Z (industrial).....	22	9.2. Cleaning.....	51
3.1. Area of application and design.....	10	4.4.6. KFA10, KFA10-W (commercial vehicles).....	24	9.3. Replacing the pump element.....	51
3.2. Pump elements.....	12	4.4.7. KFAS10, KFAS10-W (industrial).....	25	<b>10. Malfunctions</b> .....	<b>53</b>
3.3. Pressure regulating valve.....	13	4.5. Installation of pump elements.....	27	10.1. Fault indications on piston pump units without control unit.....	53
3.4. Fill level monitoring.....	14	4.6. Lubrication line connection.....	28	10.1.1. Piston pump units without fill level monitoring (KFA..).....	53
3.4.1. Visual fill level monitoring.....	14	4.7. Lubrication line arrangement.....	28	10.1.2. Piston pump units with integrated fill level monitoring (KFA..-W).....	53
3.4.2. Electrical fill level monitoring.....	14	<b>5. Transport, delivery, and storage</b> .....	<b>31</b>	10.2. Fault analysis and rectification.....	53
3.5. Electronic control unit (optional).....	14	5.1. Transport.....	31	<b>11. Technical data</b> .....	<b>55</b>
		5.2. Delivery.....	31		
		5.3. Storage.....	31		
		5.3.1. Storage of lubrication units.....	31		

## Information concerning EC Declaration of Incorporation

The product

**piston pump unit with reservoir**

of the series:

**KFA1-..., KFA10-..  
KFAS1-..., KFAS10-..**

SKF herewith certifies that it conforms to the pertinent safety requirements set forth in the following Council Directive(s) for the harmonisation of the laws of the Member States...

- **Machinery Directive 2006/42/EC**
- **Electromagnetic Compatibility 2014/30/EU**
- **Electromagnetic Compatibility 2004/104/EC**
- **RoHS Directive 2011/65/EU**

...

SKF further declares that the above mentioned product is meant for integration into a machinery / for connection to other machinery according to the **EC-Machinery Directive 2006/42/EC, Appendix II Part B**. Starting up the product is not permissible until it is assured that the machinery, vehicle or the like in which the product was installed meets the provisions and requirements of the regulations set forth in the EC Directive 2006/42/EC.

### Notes:

- (a) This declaration certifies conformity with the aforementioned directive(s), but does not contain any assurance of properties.
- (b) The safety instructions in the owner's manual must be observed.
- (c) The certified product must not be started up until it is confirmed that the equipment, machinery, vehicle or the like in which the product was installed meets the provisions and requirements of the national directives to be applied. This is in particular important for the implementation of the Use of Work Directive.
- (d) Operation of the products on non-standard main voltage as well as nonobservance of installation instructions can affect the EMC properties and electrical safety.
  - (a)

### Notes on the Low Voltage Directive 2014/35/EU

The protective regulations of the Low Voltage Directive 2014/35/EU are fulfilled according to annex I (1.5.1) of Machinery Directive 2006/42/EC.

### Notes on the Pressure Equipment Directive 2014/68/EU

Due to its performance characteristics, the product does not reach the limit values defined in Article 4, Paragraph 1, Subparagraph (a) item (i) and is, pursuant to Article 4, Paragraph 3, excluded from the scope of Pressure Equipment Directive 2014/68/EU.

The EC Declaration of Incorporation is part of the product documentation. This document is delivered with the product.

## General information

### Explanation of symbols and signs

You will find these symbols, which warn of specific dangers to persons, material assets, or the environment, next to all safety instructions in these owner's manual.

Please heed these instructions and proceed with special care in such cases. Please pass all safety instructions to other users.





Instructions attached directly to the equipment, such as rotational direction arrows and fluid connection labels, must be followed. Replace such signs if they become illegible.

- Rotational direction arrow
- Fluid connection label

Read this Owner's Manual before installing, operating or maintaining the product. Failure to follow the instructions and safety precautions in this owner's manual could result in serious injury, death, or property damage. Keep for future reference.

**Note:** Not every symbol and corresponding information described in the Safety Information is used in this owner's manual.



**Table of 1 Hazard symbols**

Symbol	Standard	Meaning
	DIN 4844-2 W000	General hazard
	DIN 4844-2 W008	Voltage
	DIN 4844-2 W026	Slip hazard
	DIN 4844-2 W028	Hot surface

**Table 2 Safety signal words and their meaning**

Signal word	Meaning
Danger!	Danger of bodily injury
Warning!	Danger of damage to property or the environment
Note	Additional information

**Table 3 Informational symbols**

Symbol	Meaning
	Note
•	Prompts an action
○	Bullet list items
➔	Refers to other facts, causes or consequences
	Provides additional information

## 1. Safety instructions



The operator of the described product must ensure that the owner's manual are read and understood by all persons tasked with the assembly, operation, maintenance, and repair of the product. The owner's manual must be kept readily available.



Note that the owner's manual form part of the product and must accompany the product if sold to a new owner.

The described product is manufactured in accordance with the generally accepted rules and standards of industry practice and with occupational safety and accident prevention regulations. Risks may, however, arise from its usage and may result in physical harm to persons or damage to other material assets. Therefore the product may only be used in proper technical condition and in observance of the owner's manual. In particular, any malfunctions which may affect safety must be remedied immediately.



In addition to the owner's manual, statutory regulations and other general regulations for accident prevention and environmental protection must be observed and applied.

### 1.1. Intended use



All products from SKF Lubrication Systems Germany GmbH may be used only for their intended purpose and in accordance with the information in the product's owner's manual.

The described product is for supplying centralized lubrication systems with lubricant and is intended for use in centralized lubrication systems. Any other use of this product constitutes improper use.

Hazardous materials of any kind, especially the materials classified as hazardous by CLP Regulation EC 1272/2008 may only be used to fill SKF centralized lubrication systems and components and delivered and/or distributed with the same after consulting with and receiving written approval from SKF.

None of the products manufactured by SKF Lubrication Systems Germany GmbH can be used with gases, liquefied gases, gases dissolved under pressure, steams or fluids that will reach a steam pressure of more than 0.5 bar above the normal atmospheric pressure (1013 mbar) in the permissible application temperature range.

Unless specially indicated otherwise, products from SKF Lubrication Systems Germany GmbH are not approved for use in potentially explosive areas as defined in the ATEX Directive 94/9/EC.

### 1.2. Authorized personnel

The products described in the installation instructions may only be installed, operated, maintained, and repaired by qualified experts. Qualified experts are persons who have been trained, instructed, and familiarized with the end product into which the described product is installed. These persons are considered capable of such tasks due to their education, training, and experience with valid standards, conditions, accident prevention regulations, and installation measures. They should be able to carry out the required tasks and to recognize - and thus avoid - any dangers that might otherwise occur.

A definition of what constitutes a qualified person and who are unqualified persons are stipulated in DIN VDE 0105 and IEC 364.

### 1.3. Electric shock hazard

Electrical connections for the described product may only be established by qualified and trained personnel authorized to do so by the operator, and in observance of the local conditions for connections and local regulations (e.g., DIN, VDE). Serious injury or death and property damage may result from improperly connected products.

**Danger!**

Performing work on an energized pump or product may result in serious injury or death. Assembly, maintenance, and repair work may only be performed on products that have been de-energized by qualified technical personnel. The supply voltage must be switched off before opening any of the product's components.

### 1.4. System pressure hazard

**Danger!**

Centralized lubrication systems are pressurized during operation. Centralized lubrication systems must therefore be depressurized before starting assembly, maintenance or repair work, or any system modifications or system repairs.

### 1.5. Warranty and liability

SKF Lubrication Systems Germany GmbH assumes no warranty or liability for the following:

- Non-compliant usage
- Improper assembly/disassembly or improper operation
- Use of unsuitable or contaminated lubricants
- Maintenance and repair work performed improperly or not performed at all
- Use of non-original SKF spare parts
- Alterations or modifications performed without written approval from SKF Lubrication Systems Germany GmbH
- Non-compliance with the instructions for transport and storage

## 2. Lubricants

### 2.1. General information



All products from SKF Lubrication Systems Germany GmbH may be used only for their intended purpose and in accordance with the information in the product's owner's manual.

Intended use is the use of the products for the purpose of providing centralized lubrication/lubrication of bearings and friction points using lubricants within the physical usage limits which can be found in the documentation for the product, e.g. owner's manual/operating instructions and the product descriptions, e.g. technical drawings and catalogs.

Particular attention is called to the fact that hazardous materials of any kind, especially those materials classified as hazardous by EC Directive 67/548/EEC, Article 2, Para. 2, may only be filled into centralized lubrication systems and components and delivered and/or distributed with such systems and components after consulting with and obtaining written approval from SKF Lubrication Systems Germany GmbH .

No products manufactured by SKF Lubrication Systems Germany GmbH are approved for use in conjunction with gases, liquefied gases, pressurized gases in solution, vapors, or such fluids whose vapor pressure exceeds normal atmospheric pressure

(1013 mbar) by more than 0.5 bar at their maximum permissible temperature.

Other media which are neither lubricant nor hazardous substance may only be fed after consulting with and obtaining written approval from SKF Lubrication Systems Germany GmbH .

SKF Lubrication Systems Germany GmbH considers lubricants to be a component of the system design and must be factored into the selection of components and the design of centralized lubrication systems. The lubricating properties of the lubricants are critically important in making these selections.

### 2.2. Selection of lubricants



#### Warning!

The amount of lubricant required at a lubrication point is specified by the bearing or machine manufacturer. It must be ensured that that the required quantity of lubricant is provided to the lubrication point. The lubrication point may otherwise not receive adequate lubrication, which can lead to damage and failure of the bearing.



Observe the instructions from the machine manufacturer regarding the lubricants that are to be used.

The selection of a lubricant suitable for the lubrication task is made by the machine/system manufacturer and/or the operator of the machine/system in cooperation with the lubricant supplier. When selecting a lubricant, the type of bearing/friction point, the expected load during operation, and the anticipated ambient conditions must be taken into account. All economic and ecological aspects must also be considered.



If required, SKF Lubrication Systems Germany GmbH can help customers to select suitable components for the conveyance of the selected lubricant and to plan and design their centralized lubrication system.

Please contact SKF Lubrication Systems Germany GmbH if you have further questions regarding lubricants. Lubricants can be tested in the company's laboratory for their suitability for pumping in centralized lubrication systems (e.g., "bleeding").

You can request an overview of the lubricant tests offered by SKF Lubrication Systems Germany GmbH from the company's Service department.



### 2.3. Approved lubricants

**Warning!**

Only lubricants approved for the product may be used. Unapproved lubricants that are unsuitable can lead to failure of the product and damage to property.

**Warning!**

Different lubricants must not be mixed together. Doing so can cause damage and require extensive cleaning of the product/centralized lubrication system. It is recommended that an indication of the lubricant in use be attached to the lubricant reservoir in order to prevent accidental mixing of lubricants.

The described product can be operated using lubricants that meet the specifications in the technical data.

Note that in rare cases, there may be lubricants whose properties are within the permissible limits values but whose other characteristics render them unsuitable for use in centralized lubrication systems. For example, synthetic lubricants may be incompatible with elastomers.

### 2.4. Lubricants and the environment

**Warning!**

Lubricants can contaminate soil and bodies of water. Lubricants must be used and disposed of properly. Observe the local regulations and laws regarding the disposal of lubricants.

It is important to note that lubricants are environmentally hazardous, flammable substances that require special precautionary measures during transport, storage, and processing. Consult the safety data sheet from the lubricant manufacturer for information regarding transport, storage, processing, and environmental hazards of the lubricant that will be used. The safety data sheet for a lubricant can be requested from the lubricant manufacturer.

### 2.5. Lubricant hazards

**Danger!**

Centralized lubrication systems must always be free of leaks. Leaking lubricant is hazardous due to the risk of slipping and injury. Beware of any lubricant leaking out during assembly, operation, maintenance, or repair of centralized lubrication systems. Leaks must be sealed without delay.

Lubricant leaking from centralized lubrication systems is a serious hazard. Leaking lubricant can create risks that may result in physical harm to persons or damage to other material assets.



Follow the safety instructions on the lubricant's safety data sheet.

Lubricants are hazardous substances. The safety instructions on the lubricant's safety data sheet must be strictly followed. The safety data sheet for a lubricant can be requested from the lubricant manufacturer.

## 3. Design and function

### 3.1. Area of application and design

The piston pump units with reservoir described here are characterized by their compact construction. Depending on the model design, they are suitable for supplying lubricant to centralized lubrication systems with progressive distributors on machines, systems or vehicles (→ Table4). Piston pump units with reservoir deliver greases up to NLGI Grade 2.

Piston pump units with reservoir differ in the way they can be electrically connected as well as in the control and monitoring of functions. Up to two independent zones can be operated by installing a maximum of two pump elements.

The standard design of piston pump units with reservoir consist of a pump housing and a lubricant reservoir.

The lubricant reservoir is made of plastic and is equipped with a spring-loaded follower piston.

The pump housing contains the electric motor, the mechanics for driving the pump elements and, depending on the model design, the control unit. All other functional and connection elements are arranged on the pump housing.

**Table 4 Model designs**

Application	Description	Monitoring		Control		Mounted manifold
		Fill level	Cycle switch	External	Internal	
Commercial vehicles 12 V / 24 V DC	KFA1	-	-	•	-	-
	KFA1-W	•	-	•	-	-
	KFAS1	-	-	-	•	-
	KFAS1-W	•	-	-	•	-
	KFAS1-W-3 (4, ...9)	•	-	-	•	•
Industrial 24 V DC	KFA1-M	-	-	•	-	-
	KFA1-M-W	•	-	•	-	-
	KFAS1-M	-	-	-	•	-
	KFAS1-M-Z	-	•	-	•	-
	KFAS1-M-W	•	-	-	•	-
	KFAS1-M-W-Z	•	•	-	•	-
Industrial 115 V / 230 V AC	KFA10	-	-	•	-	-
	KFA10-W	•	-	•	-	-
	KFAS10	-	-	-	•	-
	KFAS10-W	•	-	-	•	-
	KFAS10-W-3 (4, ...9)	•	-	-	•	•

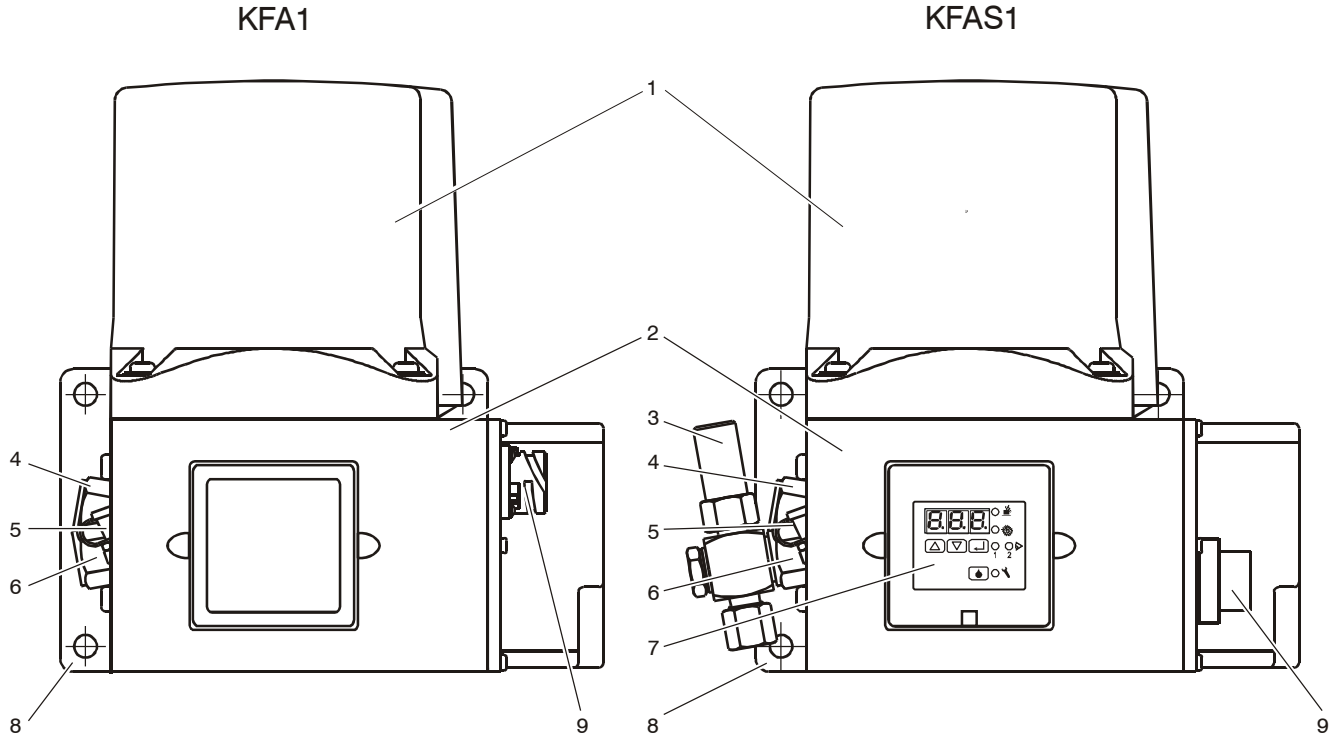

Fig. 1. Piston pump units with reservoir, series KFA1 and KFAS1

- |                             |   |                          |
|-----------------------------|---|--------------------------|
| 1 Lubricant reservoir       | 4 Lubricant outlet 1                              | 7 Control screen         |
| 2 Pump housing              | 5 Filler socket                                   | 8 Mounting flange        |
| 3 Pressure regulating valve | 6 Lubricant outlet 2 (with pump element on KFAS1) | 9 Electrical connections |

### 3.2. Pump elements

Piston pump units with reservoir possess two lubricant outlets that can be equipped with a pump element. Unused pump outlets must be closed using a screw plug.

The pump elements meter the lubricant then feed it into the main lubricant line of the centralized lubrication system.

Model designs with progressive distributors (3- to 9-port) mounted on the pump housing feed the lubricant directly into the progressive distributor. The lubricant is then transported from the feeder's outlets directly to the lubrication points.

The pump elements are designed for different delivery rates depending on the lubrication task. The different designs are indicated by grooves on the wrench flat (→ Table5).

For additional details about the pump elements, see the associated documentation.



If no documentation is available, you can request the documentation directly from SKF Lubrication Systems Germany GmbH .



**Fig.2. Pump element with O-ring (item 1)**

**Table 5. Available pump elements**

Order No.	Delivery rate in $\text{cm}^3/\text{min}^{1)}$	Number of grooves
KFA1.U1	2,0	1
KFA1.U2	1,5	2
KFA1.U3	1,0	3

<sup>1)</sup> Output of NLGI Grade 2 grease at a temperature of 20 °C and back pressure of 50 bar

## 3.3. Pressure regulating valve

**Danger!**

Piston pump units with reservoir must only be operated with the pressure control valve installed. Non-observance may result in severe injury or death and damage to property due to overpressure.

The pressure control valve prevents excessive pressure in the entire lubrication system. It is mounted directly on the lubricant outlet. If the system pressure exceeds the cracking pressure of the pressure regulating valve, the valve opens and lubricant escapes at the valve.

For additional details about the pressure relief valve, see the associated documentation.



If no documentation is available, you can request the documentation directly from SKF Lubrication Systems Germany GmbH.

**Table 6. Pressure regulating valves**

Order No.	Pipe Ø in mm	Cracking pressure in bar
161-210-012	6	300 ± 20

**Table 7. Pressure regulating valves with T connector**

Order No.	Pipe Ø in mm	Cracking pressure in bar
161-210-016	10	300 ± 20
161-210-030	10	200 ± 20
161-210-031	8	200 ± 20
161-210-032	6	200 ± 20
161-210-040	10	120 ± 5
161-210-041	8	120 ± 5
161-210-042	6	120 ± 5

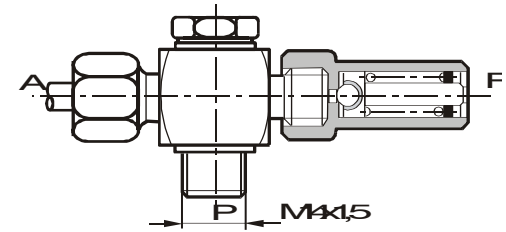
**Fig.3. Pressure regulating valve**

A Connection for lubricant line

P Pipe thread for pump element

R Lubricant leakage on malfunction

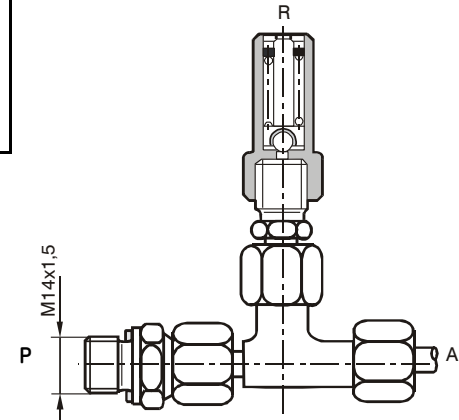
**Fig.4. Pressure regulating valve with T connector**

A Connection for lubricant line

R Lubricant leakage on malfunction

### 3.4. Fill level monitoring

#### 3.4.1. Visual fill level monitoring



##### **Danger!**

The lubricant reservoir fill level must be checked regularly on piston pump units with reservoir that are not equipped with electrical fill level monitoring. Proper lubrication is no longer guaranteed if the fill level falls below the "min." mark, which can result in severe injury or death and property damage.



The entire centralized lubrication system must be vented if the lubricant reservoir fill level has fallen below the "min." mark.

The lubricant reservoir is transparent and has marks indicating the maximum and minimum fill level. The current level can be seen from the position of the follower piston.

#### 3.4.2. Electrical fill level monitoring

Piston pump units with reservoir can optionally be equipped with a fill level switch. When the fill level in the lubricant reservoir reaches the "min." mark, one of the following occurs depending on the model design:

- On piston pump units with integrated control unit, the operational sequence is stopped and a fault message appears on the control screen.
- On piston pump units without control unit, the signal is issued via the corresponding connector.

### 3.5. Electronic control unit (optional)

Depending on the model design, the piston pump units with reservoir may be equipped with a programmable electronic control unit that controls and monitors the lubrication procedure.

#### 3.5.1. Modes of operation

Piston pump units with reservoir can be operated in different modes. The units always operate cyclically, i.e. a lubrication procedure (contact time) during which the piston pump runs and supplies the lubrication points is followed by a lubrication pause (interval time). One lubrication cycle consists of a contact time and an interval time.

##### **Timer mode**

The contact time and interval time are timer-controlled.

**PAUSE:** Values in **hours**  
**CONTACT:** Values in **minutes**

##### **Counter mode (only KFAS)**

The contact time is timer-controlled. The interval time depends on the number of pulses, i.e. the interval lasts until the control unit receives an

adjustable number of pulses from an external pulse generator.



Connect an external pulse generator to input DK/MK.

**PAUSE:** Values in **pulses**  
**CONTACT:** Values in **minutes**

#### 3.5.2. Contact time (pump cycle time)

The duration of the contact time is programmable. With progressive distributor monitoring deactivated, the duration of the lubrication procedure corresponds to the set contact time.

#### 3.5.3. Interval time

The duration of the interval time is programmable.

#### 3.5.4. System monitoring

The system monitoring function is optional and includes monitoring of:

- A fill level switch (if present) and/or
- One or two progressive distributors by one or two cycle switches, respectively

Progressive distributor monitoring can be activated and deactivated.

The monitoring of the fill level switch, if present, always remains active.

In case of a fault, e.g. insufficient fill level, a fault message is generated and the operational sequence is stopped. The cause of the malfunction can be shown on the control unit's screen. In addition, the fault hours figure is stored and can also be displayed.

### 3.5.5. Progressive distributor monitoring

The progressive distributor monitoring capabilities differ on the KFAS and KFAS1-B series as follows:

#### KFAS

- Progressive distributor monitoring using one cycle switch
- Number of edges for cycle switch is not adjustable

With each piston stroke of the corresponding progressive distributor, the cycle switches generate a switching edge, which is registered by the control unit and used to control the contact time. The number of switching edges (stroke number) required to limit the contact time can be set on the control unit. Two switching edges are required for one revolution of the progressive distributor.

### 3.5.6. Block mode

When progressive distributor monitoring is active, the duration of the lubrication procedure corresponds at least to the set contact time, though the programmed number of switching edges for the cycle switch(es) must also be attained. If the required number of switching edges for the cycle switch(es) is not attained during the contact time, an

additional contact time is started after a defined delay. This process can be repeated up to three times. This process is also referred to as block operation, as the piston pump starts and stops quickly several times.

Block operation is interrupted as soon as the set number of piston detector signals has been received. The length of an interval time following a successful block operation is not changed. Operation continues as normal. If the required number of switching edges for the cycle switch(es) is not attained during block operation, a fault message is issued.

### 3.5.7. Fill level monitoring

On units with fill level switch, the fill level is monitored by the control unit. As soon as the fill level of the lubricant reservoir falls below the minimum, the control unit stops the operational sequence of the centralized lubrication system and issues a fault message. If fill level monitoring is installed, it is always active.

### 3.5.8. Parameter memory

All essential system parameters are stored in the control unit's non-volatile memory, ensuring that no data is lost even in case of power failure or a completely.

## 3.6. Piston pump units with progressive distributor installed

Piston pump units of the KFA(S) series can optionally be equipped with a progressive distributor. The progressive distributor is mounted at the base of the pump housing. The number of lubricant connections on the mounted progressive distributor is variable and must be specified when ordering.

## 4. Assembly instructions

### 4.1. General information

Only qualified technical personnel may install, operate, maintain, and repair the piston pump units described in the assembly instructions. Qualified technical personnel are persons who have been trained, assigned and instructed by the operator of the final product into which the described piston pump units are incorporated. Such persons are familiar with the relevant standards, rules, accident prevention regulations, and operating conditions as a result of their training, experience, and instruction. They are qualified to carry out the required activities and in doing so recognize and avoid potential hazards.

The definition of qualified personnel and the prohibition against employing non-qualified personnel are laid down in DIN VDE 0105 and IEC 364.

Before assembling/setting up the piston pump unit with reservoir, the packaging material and any shipping braces (e.g., plugs) must be removed. Keep the packaging material until any discrepancies have been resolved.



#### **Warning!**

The product must not be tilted or dropped.

During all assembly work on commercial vehicles or machinery, observe the local accident prevention regulations as well as the applicable operating and maintenance specifications.

### 4.2. Setup and attachment

The piston pump unit with reservoir should be protected from humidity and vibration, and should be mounted so that it is easily accessible, allowing all further installation work to be done without difficulty. The control screen, if present, must be easily visible and reachable.

Ensure that there is sufficient air circulation to prevent excessive heating of the piston pump unit with reservoir. For the maximum permissible ambient temperature, see → "Technical data."



For the product-specific technical data on a specific piston pump unit with reservoir, see the relevant documentation. If no documentation is available, you can request the documentation directly from SKF Lubrication Systems Germany GmbH .

The mounting position of the piston pump unit with reservoir is vertical as shown in the → documentation.

Drill the assembly holes for wall-mounting the piston pump unit as specified in → Chapter 4.3, "Connection dimensions."



**Warning!**

During assembly and especially when drilling, always pay attention to the following:

- Existing supply lines must not be damaged by assembly work.
- Other units must not be damaged by assembly work.
- The piston pump unit must not be installed within range of moving parts.
- The piston pump unit must be installed at an adequate distance from sources of heat.
- Maintain safety clearances and comply with local regulations for assembly and accident prevention.
- Use existing holes on the vehicle frame or other vehicle parts.
- Bridge large holes using body washers.
- Pay attention to steering lock angle, spring action and possible wearing spots during assembly.

**Warning!**

The → German Ordinance on the National and International Carriage of Dangerous Goods by Road, Rail and Inland Waterways (GGVSEB) must be observed for tankers and other vehicles that transport hazardous goods.

**Warning!**

Any change to a commercial vehicle, especially the installation of additional equipment such as centralized lubrication systems, must be checked and approved by the competent technical authorities in the operator country. Non-observance can void the license to operate the commercial vehicle.

### 4.3. Connection dimensions

Piston pump units with reservoir are designed for wall mounting (industrial design) or installation on a vehicle (commercial vehicle design). The piston pump unit with reservoir is mounted on a connecting flange with three fastening points. It is fastened using three M8 screws, washers and self-locking nuts. The tightening torque is 16 Nm.

For the dimensions and location of the fastening holes, see the → documentation of the piston pump unit with reservoir. If no documentation is available, the dimensions and location of the fastening holes on the connecting flange can be determined by taking measurements.



If no documentation is available, you can request the documentation directly from SKF Lubrication Systems Germany GmbH.

## 4.4. Electrical connection

### 4.4.1. Electric motor connection

Piston pump units with reservoir are driven by electric motors.

The general conditions for connections are given in → Table 8.



#### Danger!

Electrical connections for the piston pump unit with reservoir may only be established by qualified and trained personnel authorized to do so by the operator, and in observance of the local conditions for connections and local regulations (e.g., DIN, VDE). Incorrectly connected piston pump units with reservoir can cause considerable damage to property and result in serious injury or death.



#### Danger!

The mains voltage (supply voltage) must match the specifications on the → rating plate of the piston pump unit. Check the fuse protection of the electrical circuit. Use only fuses with the prescribed amperage, else bodily injury and property damage may result.

**Table 8 General conditions for connections**

Design	Rated voltage	Typical power consumption (load-dependent) <sup>1)</sup>	Starting current (approx. 20 ms) / Inrush current <sup>3)</sup>	Back-up fuse
<b>KFA1... / KFAS1...</b>	24 V DC	0.5 A	approx. 1.4 A	3.0 A
<b>Commercial vehicles</b> Mode S3 20%, 50 min	12 V DC	1.0 A	approx. 2.8 A	3.0 A
<b>KFA1-M... / KFAS1-M...</b>	24 V DC <sup>2)</sup>	0.5 A	approx. 1.4 A	3.0 A
<b>Industrial</b> Mode S3 20%, 50 min				
<b>KFA10 / KFA10-W</b>	230 V/50 Hz	0.77 A	-	3.0 A
<b>Industrial</b>	230 V/60 Hz	0.54 A	-	3.0 A
Mode S3 5%, 100 min	115 V/50 Hz	1.54 A	-	3.0 A
	115 V/60 Hz	1.08 A	-	3.0 A
<b>KFAS10 / KFAS10-W</b>	230 V 50/60 Hz	0.40 A	40 A	2.5 A
<b>Industrial</b>	115 V 50/60 Hz	0.65 A	20 A	2.5 A
Mode S3 20%, 50 min				2.5 A
				2.5 A

<sup>1)</sup> Typical value at an ambient temperature = 20 °C and operating pressure = 300 bar

<sup>2)</sup> Protective measures to be taken for operation according to intended use:

"Functional Extra Low Voltage" / "Protective Extra Low Voltage" (PELV)

<sup>3)</sup> only model design KFAS10-... with switch-mode power supply

## 4.4.2. KFA1, KFA1-W (commercial vehicles)



Supply voltage 12/24 V DC



For voltage specifications, see the →  
rating plate of the piston pump unit and  
→ Table 8.

The electrical connection of the piston pump units is established via a 4-pin circular connector according to → DIN 72585-A1-4.1-Ag/K1.

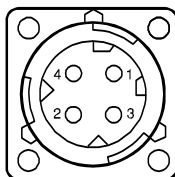

X1

Fig.5. Circular connector

Table 9. X1 4-pin circular connector

X1 PIN	Color abbreviation	Color coding
1	RD-BK	Red-black
2	BN	Brown
3	BK	Black
4	PK	Pink

## KFA1 without fill level monitoring

Table 10. Cable set

Order No.	Length of corrugated hose	Length of wires
997-000-820	10 m	12 m

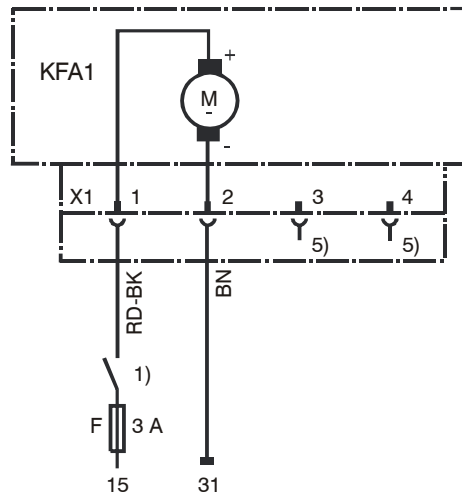

Fig.6. Electrical connection of KFA1

- 1) External control unit; relay contact "Pump ON"
  - 5) PIN without internal connection
- F Fuse

See → Table9 for color coding.

## KFA1-W with fill level monitoring

Table 11. Cable set

Order No.	Length of corrugated hose	Length of wires
997-000-706	10 m	12 m

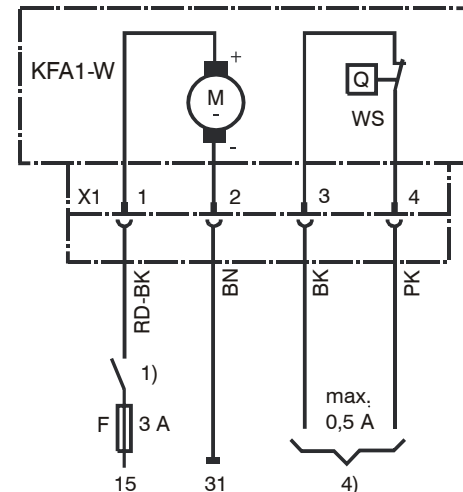

Fig.7. Electrical connection of KFA1-W

- WS Integrated fill level switch  
Contact position shown: "filled reservoir",  
i.e. the fill level switch opens when the  
lubricant quantity is insufficient
- 4) Evaluation of fill level switch signal

See → Table9 for color coding.

#### 4.4.3. KFAS1, KFAS1-W (commercial vehicles)



Supply voltage 12/24 V DC



For voltage specifications, see the → rating plate of the piston pump unit and → Table 8.

The electrical connection is established via a 7-pin circular connector (AMP type).

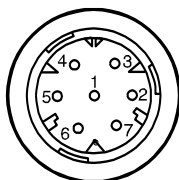

X1

Fig.8. Circular connector

Table 12. X1 7-pin circular connector

X1 PIN	Color abbreviation	Color coding
1	BN	Brown
2	RD-BK	Red-black
3	BU	Blue
4	PK	Pink
5	YE	Yellow
6	BK	Black
7	VT-GN	Purple-green

#### KFAS1/KFAS1-W

##### without cycle switch monitoring

PINS 5 and 6 have no function. Do not bridge! The following monitoring setting must be active in programming mode: COP = OFF (factory setting).

##### With cycle switch monitoring

Connect the external cycle switch to PINS 5 and 6.

The following monitoring setting must be activated in programming mode: COP = CS (→ Chapter 7.1.3.3, "Set monitoring functions (KFAS)").

#### KFAS1

No internal fill level monitoring

#### KFAS1-W

With internal fill level monitoring

If fill level monitoring is installed, it is always active. If the fill level falls below the "min." mark, the operational sequence is stopped and a fault message appears on the screen.

The electrical connection details are identical with those of the KFAS1 piston pump unit.

Table 13. Cable sets

Order No.	Length of corrugated hose	Length of wires
997-000-630	12 m	12.2 m
997-000-650	16 m	16.2 m

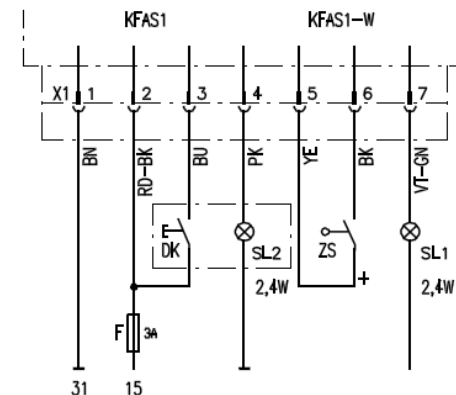

Fig.9. Electrical connection of KFAS1 and KFAS1-W

15 + Supply voltage potential (ignition switch ON)

31 - Supply voltage potential (0 V, GND)

DK External pushbutton "Interim lubrication"

ZS External cycle switch

SL1 Signal lamp "Pump ON"

SL2 Signal lamp "Fault"

F Fuse

See → Table12 for color coding.

4.4.4. KFA1-M, KFA1-M-W (industrial)



Supply voltage 24 V DC



For voltage specifications, see the → rating plate of the piston pump unit and → Table 8.

**X1** Electrical connection: Plug connector acc. to → DIN 175301-803.

**X2** Signal output from fill level switch WS; M12x1 circular connector.

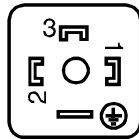

X1  
Plug

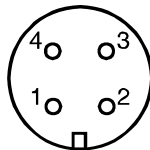

X2

Fig.10. KFA1-M-W plug connector

**KFA1-M without fill level monitoring**

The piston pump unit possesses an X1 plug connector.

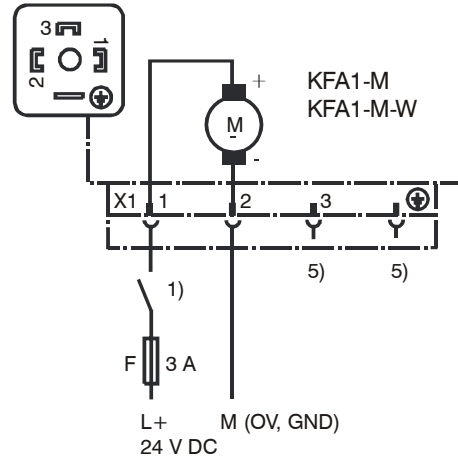

Fig.11. X1 plug connector

- 1) External control unit; relay contact "Pump ON"
- 5) PIN without internal connection
- L+ + Supply voltage potential (main machine switch ON)
- M - Supply voltage potential

**KFA1-M-W with fill level monitoring**

The piston pump unit possesses an X1 and X2 plug connector.

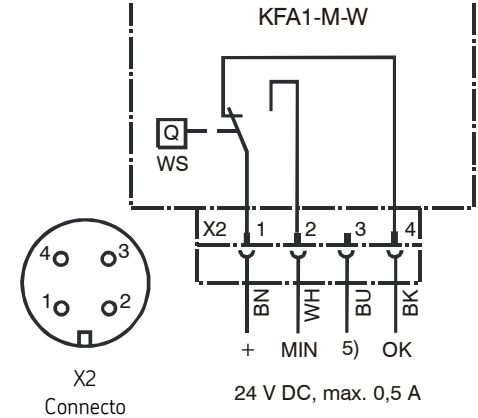

Fig.12. X2 circular connector

- WS Integrated fill level switch
- Contact position shown: "filled reservoir", i.e. contacts 1-4 open when the lubricant quantity is insufficient

Table 14. Color coding

X2 PIN	Color abbreviation	Color coding
1	BN	Brown
2	WH	White
3	BU	Blue
4	BK	Black

#### 4.4.5. KFA51-M, KFA51-M-W, KFA51-M-Z, KFA51-M-W-Z (industrial)



Supply voltage 24 V DC



For voltage specifications, see the → rating plate of the piston pump unit and → Table 8.

- X1** Electrical connection: Plug connector according to → DIN 175301-803. **Applies to all piston pump units of the KFA51-M series.**
- X3** Connection of external cycle switches; M12x1 circular connector.

##### KFA51-M

The piston pump unit possesses an X1 plug connector.

- No internal fill level monitoring
- No external cycle switch monitoring

##### KFA51-M-W

The piston pump unit possesses an X1 plug connector.

- With internal fill level monitoring. If fill level monitoring is installed, it is always active. If the fill level reaches the "min." mark, the operational sequence is stopped and the fault message **F L L** appears on the screen.
- No external cycle switch monitoring

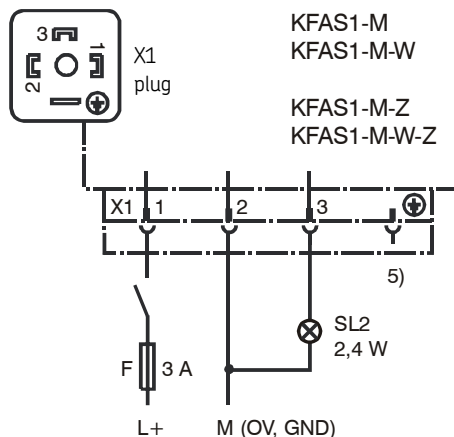

**Fig.13. Connection of KFA51-M, KFA51-M-W, KFA51-M-Z and KFA51-M-W-Z**

##### X1 Plug connector for supply voltage

**L+** + Supply voltage potential

**M** - Supply voltage potential

**5)** PIN without internal connection

**SL2** Signal lamp "malfunction"

##### KFA51-M-Z

The piston pump unit is equipped with an X1 plug connector for the supply voltage and an M12x1 circular connector for an external cycle switch (X3).

- No internal fill level monitoring.
- See → next page for connection of external cycle switches.

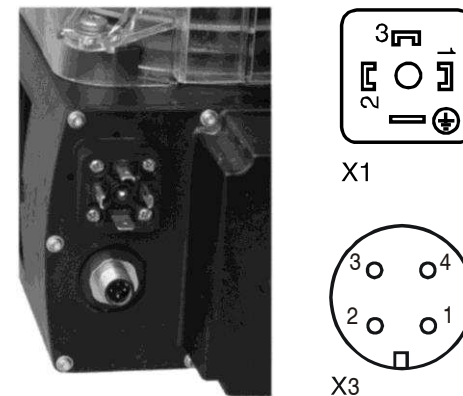

**Fig.14. KFA51-M-Z and KFA51-M-W-Z plug connectors**

##### KFA51-M-W-Z

The piston pump unit is equipped with an X1 plug connector for the supply voltage and an M12x1 circular connector for an external cycle switch (X3).

- With internal fill level monitoring. If fill level monitoring is installed, it is always active. If the fill level reaches the "min." mark, the operational sequence is stopped and the fault message **F L L** appears on the screen.
- See → next page for connection of external cycle switches.

**External cycle switch**

Only for KFAS1-M-Z and KFAS1-M-W-Z.

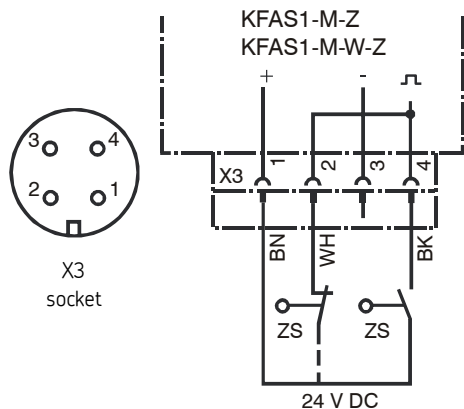

Fig.15. 2-wire switch as NC contact (WH) or NO-contact (BK)

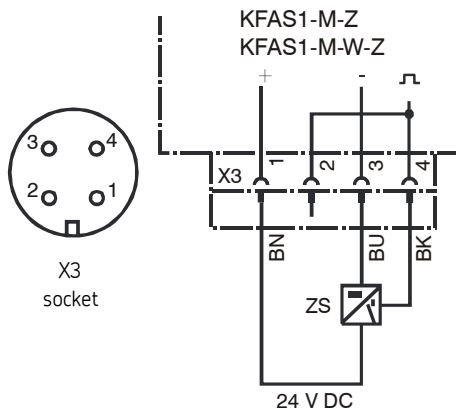

Fig.16. 3-wire switch

Table 15. Color coding

X3 PIN	Color abbreviation	Color coding
1	BN	Brown
2	WH	White
3	BU	Blue
4	BK	Black

**4.4.6. KFA10, KFA10-W (commercial vehicles)**



Supply voltage 115/230 V AC, 50Hz and 60Hz



For voltage specifications, see the → rating plate of the piston pump unit and → Table 8.

**X1** Electrical connection: Plug connector acc. to → DIN 175301-803.

**X2** Signal output from fill level switch WS; M12x1 circular connector.



Fig.17. KFA10-W plug connector

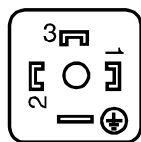

X1

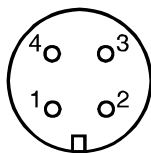

X2

**KFA10 without fill level monitoring**

The piston pump unit only possesses one X1 plug connector.

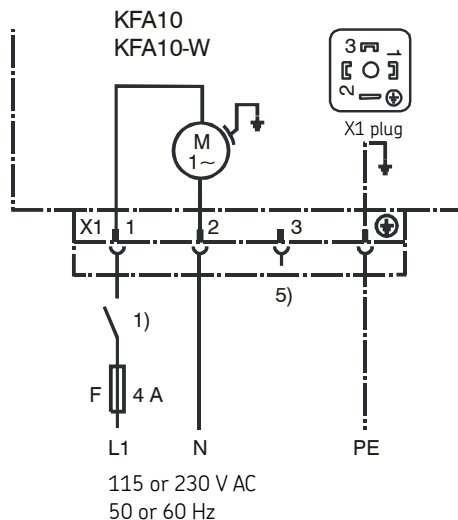

Fig.18. X1 plug connector

- 1) External control unit; relay contact "Pump ON"
- 5) PIN without internal connection

**KFA10-W with fill level monitoring**

The piston pump unit is equipped with an X1 plug connector for the supply voltage and an M12x1 (X2) circular connector for signal output from the fill level switch (WS).

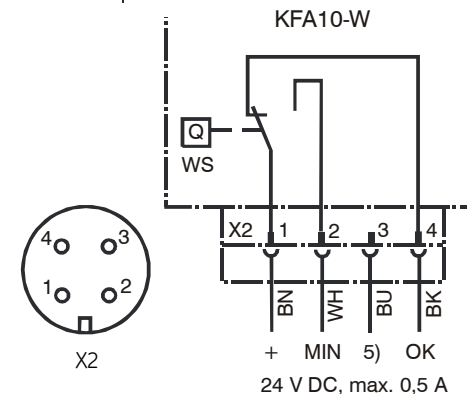

Fig.19. X2 circular connector  
WS Integrated fill level switch  
Contact position shown: "filled reservoir"

Table 16. Color coding

X2 PIN	Color abbreviation	Color coding
1	BN	Brown
2	WH	White
3	BU	Blue
4	BK	Black



#### 4.4.7. KFA510, KFA510-W (industrial)



Supply voltage 115/230 V AC, 50Hz and 60Hz



For voltage specifications, see the → rating plate of the piston pump unit and → Table 8.

**X1** Electrical connection of plug according to DIN 175301-803.

**Applies to all piston pump units of the KFA510 series.**

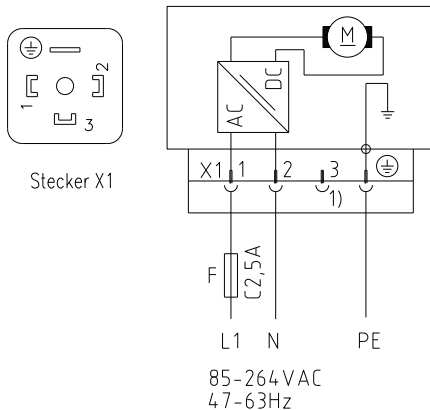

#### KFA510

The piston pump unit is equipped with an X1 plug connector and an M12x1 circular connector for cycle switch monitoring.

- No internal fill level monitoring
- With cycle switch monitoring
- With SL2 fault signal output

#### KFA510-W

The piston pump unit is equipped with an X1 plug connector and an M12x1 circular connector for cycle switch monitoring.

- With internal fill level monitoring. Internal fill level monitoring is always active. If the fill level reaches the "min." mark, the operational sequence is stopped and the fault message **F L L** appears on the screen.
- With cycle switch monitoring
- With SL2 fault signal output

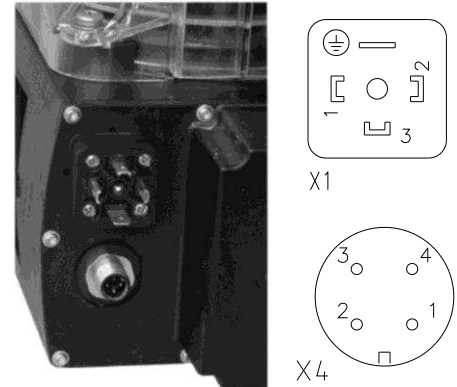

**Fig.21. KFA510 and KFA510-W plug connectors**

Monitoring by an external cycle switch and the output of a signal in case of malfunction are performed via an M12x1 circular connector. 2-wire and 3-wire cycle switches can be connected. See illustrations → Fig.22 to → Fig.24 for details about wiring.

**Fig.20. Connection of KFA510, KFA510-W,**

**X1 Plug connector for supply voltage**

**1) PIN without internal connection**

External 2-wire cycle switch

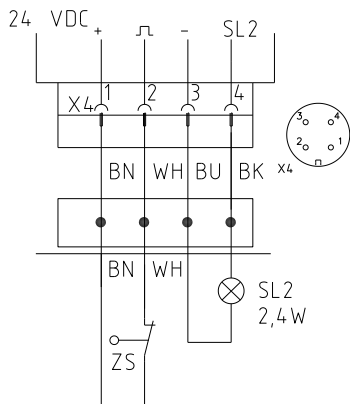

Fig.22. 2-wire switch as NC contact (WH) or NO-contact (BK)

External 3-wire cycle switch

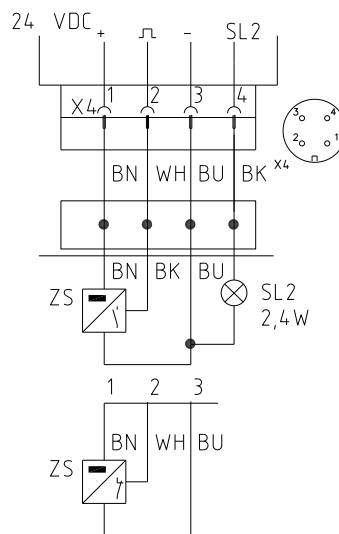

Fig.23. 3-wire switch

Signal distributor for 2-wire and 3-wire cycle switches

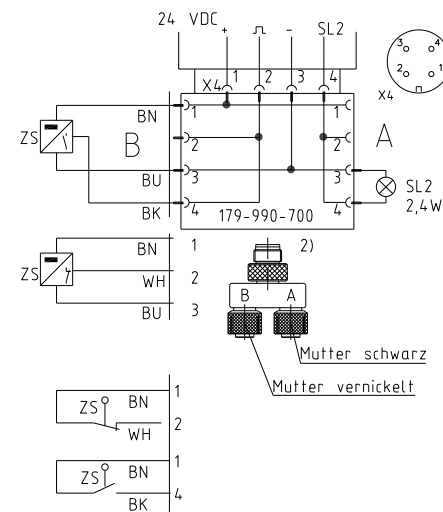

Fig.24. 2-wire and 3-wire switch with signal distributor

Table 17 Color coding

X4 PIN	Color abbreviation	Color coding
1	BN	Brown
2	WH	White
3	BU	Blue
4	BK	Black

#### 4.5. Installation of pump elements



##### **Danger!**

The piston pump unit must be de-energized before installation or removal of a pump element. Performing work on an energized pump or product may result in serious injury or death. Assembly, maintenance, and repair work may only be performed on products that have been de-energized by qualified technical personnel. The supply voltage must be switched off before opening any of the product's components.



The pump elements are fitted only with O-ring 15.4x2.1 (1) without any additional sealing ring.



**Fig.25. Pump element with O-ring (item 1)**

Install the pump elements as follows:

##### **Step 1:**

Remove screw plug (if present).

##### **Step 2:**

Remove bothersome lubricant between the internal thread, guide slot in the strainer ring and the groove between the cam disc and return disc with a suitable tool.

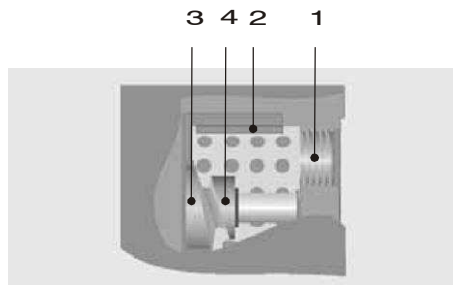

**Fig.26. Sectional top view of pump housing**

- 1 Internal thread
- 2 Guide slot in strainer ring
- 3 Cam disc
- 4 Return disc

##### **Step 3:**

Pull piston of the pump element as far as possible out of the element, and insert it along the guide slot of the strainer ring between the cam disc and return disc (→ Fig.27). If the pump element has not been correctly installed, it is not possible to tighten the thread.

Close any outlets which are not required with a screw plug according to DIN 910-M18x1.5-5.8 with sealing ring according to DIN 7603-A18x24-Al.

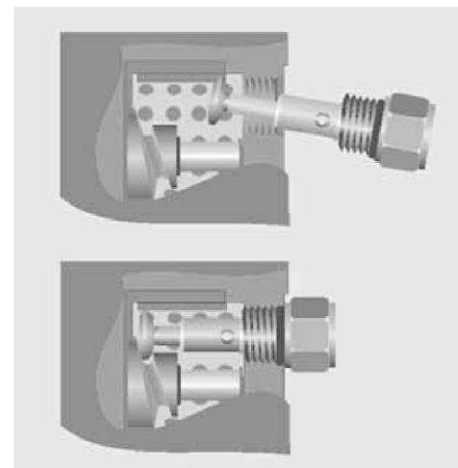

**Fig.27. Inserting the pump element**

#### 4.6. Lubrication line connection

Prior to installation, it is recommended that you fill the lubrication lines with lubricant or use pre-filled lubrication lines to simplify subsequent venting of the centralized lubrication system.

The lubrication lines must be connected to the piston pump unit in such a way that no forces can be transferred to the assembled piston pump unit (stress-free connection).



##### **Warning!**

The fittings used to connect the lubrication line should be designed for the maximum operating pressure of the piston pump unit. If they are not, the lubrication line system needs to be protected from excessive pressure by means of a pressure-limiting valve.

For operating pressures up to 250 bar as can occur especially in progressive centralized lubrication systems, SKF cutting-sleeve screw unions conforming to → DIN 2353 can be used. If using fittings from other manufacturers, pay careful attention to the → assembly instructions and → technical data from the manufacturer.

On piston pump units without mounted progressive distributor, the lubrication lines are connected directly to lubrication line connections 1 and 2 on the pump housing.

On piston pump units with mounted progressive feeder, the lubrication point lines are directly routed from the lubrication line connections on the progressive distributor to the lubrication points. The lubrication line connections on the progressive distributor are equipped with plug connectors to which the lubrication point line can be connected.

#### 4.7. Lubrication line arrangement

When arranging the main lubricant lines and lubrication point lines, observe the following instructions in order to ensure that the entire lubrication system functions smoothly.

The main lubricant line must be dimensioned in accordance with the maximum operating pressure occurring in the piston pump unit used and the delivery volume of that unit. If possible, the main lubricant line should rise upward from the piston pump unit and be ventable at the highest point on the lubrication line system.

Lubricant distributors at the end of the main lubricant line must be installed such that the outlets of the lubricant distributors point upwards. If the system configuration requires that the lubricant distributors be arranged below the main lubricant line, they should not be placed at the end of the main lubricant line.

The pipes, hoses, shutoff valves and directional control valves, fittings, etc. that will be used must be designed for the maximum operating pressure of

the piston pump unit, the permissible temperatures and the lubricants that will be delivered. The lubrication line system also needs to be protected from excessive pressure by means of a pressure-limiting valve.

All components of the lubrication line system such as pipes, hoses, shutoff valves and directional control valves, fittings, etc. must be carefully cleaned before assembly. No seals in the lubrication line system should protrude inwards in a way that disrupts the flow of the lubricant and could allow contaminants to enter the lubrication line system.

Lubrication lines should always be arranged so that air pockets cannot form anywhere. Avoid changes in the cross-section of the lubrication line from small to large cross-sections in the direction of flow of the lubricant. When the cross-section does change, the transition should be gentle.

The flow of lubricant in the lubrication lines should not be impeded by the incorporation of sharp bends, angle valves, or flap valves. Unavoidable changes in the cross-section in lubrication lines must have smooth transitions. Sudden changes of direction should be avoided if possible.

**Warning!**

Lubrication lines must always be free of leaks. Lubricants can contaminate soil and bodies of water. Lubricants must be used and disposed of properly. Observe the local regulations and laws regarding the disposal of lubricants.

**Danger!**

Centralized lubrication systems must always be free of leaks. Leaking lubricant is hazardous due to the risk of slipping and injury. Beware of any lubricant leaking out during assembly, operation, maintenance, or repair of centralized lubrication systems. Leaks must be sealed without delay.

Lubricant leaking from centralized lubrication systems is a serious hazard. Leaking lubricant can create risks that may result in physical harm to persons or damage to other material assets.



Follow the safety instructions on the  
➔ lubricant's safety data sheet.

The safety data sheet for a lubricant can be requested from the lubricant manufacturer.

## **Piston pump unit with reservoir for use in centralized lubrication systems**

## **Operating manual**

### **Product series:**

**KFA1-..., KFA10-..**

**KFAS1-..., KFAS10-...**

## 5. Transport, delivery, and storage

### 5.1. Transport

SKF Lubrication Systems Germany GmbH products are packaged in accordance with standard commercial practice according to the regulations of the recipient's country and DIN ISO 9001. Safe handling must be ensured during transport. The product must be protected from mechanical effects such as impacts. The transport packaging must be marked "Do not drop!".



#### **Warning!**

The product must not be tilted or dropped.

There are no restrictions for land, air or sea transport.

### 5.2. Delivery

Upon receiving the shipment, please check the product(s) for possible damage, and ensure that the shipment is complete according to the shipping documents. Keep the packaging material until any discrepancies have been resolved.

### 5.3. Storage

SKF Lubrication Systems Germany GmbH products are subject to the following storage conditions:

#### **5.3.1. Storage of lubrication units**

- Ambient conditions: dry and dust-free surroundings, storage in well ventilated dry area
- Storage time: max. 24 months
- Permissible humidity: < 65%
- Storage temperature: 10 - 40°C
- Light: avoid direct sun or UV exposure and shield nearby sources of heat

#### **5.3.2. Storage of electronic and electrical devices**

- Ambient conditions: dry and dust-free surroundings, storage in well ventilated dry area
- Storage time: max. 24 months
- Permissible humidity: < 65%
- Storage temperature: 10 - 40°C
- Light: avoid direct sun or UV exposure and shield nearby sources of heat

#### **5.3.3. Storage - general information**

- The product(s) can be enveloped in plastic film to provide low-dust storage.
- Protect against ground moisture by storing on a shelf or wooden pallet.
- Bright-finished metallic surfaces, especially wearing parts and assembly surfaces, must be protected using long-term anti-corrosive agents before storage.
- At approx. 6-month intervals: Check for corrosion. If there are signs of corrosion, remove them then reapply anti-corrosive agents.
- Drives must be protected from mechanical damage.

## 6. Operation

### 6.1. General information

The piston pump unit described functions automatically. You should, however, still observe the following instructions to provide for trouble-free operation:

- Perform a functional check on a regular basis by initiating an interim lubrication.
- Inspect the lubrication of the lubrication points on a regular basis.
- Perform a visual check of the lubricant fill level in the lubricant reservoir at regular intervals (including on piston pump units with fill level monitoring).

If the lubricant fill level is too low, top up to the maximum mark as described in → Chapter 6.2, "Filling the lubricant reservoir".



#### Warning!

The lubricant reservoir must not be completely emptied, as this may result in damage or destruction of the machine components requiring lubrication.

If the lubricant reservoir has been emptied to the point that lubricant no longer flows from the outlets, the entire centralized lubrication system must be refilled and then vented (→ Chapter 6.3, "Vent centralized lubrication system").

### 6.2. Filling the lubricant reservoir



Observe the instructions from the machine manufacturer regarding the lubricants that are to be used.



#### Warning!

Only fill using clean lubricant and an appropriate device. Contaminated lubricants can result in severe system malfunction. The lubricant reservoir must be filled without introducing bubbles.



#### Warning!

Different lubricants must not be mixed together. Doing so can cause damage and require extensive cleaning of the piston pump unit/centralized lubrication system. It is recommended that an indication of the lubricant in use be attached to the lubricant reservoir in order to prevent accidental mixing of lubricants.

The lubricant may only be fed without bubbles. The lubricant reservoir, if present, must be filled with clean lubricant without introducing bubbles. Lubricant is filled using a DIN 71412-AM10x1 conical head nipple and a conventional grease press.

When the unit is filled for the first time, the lubricant forces the follower piston upward until the overflow outlet opens. As filling continues, the air escapes until the entire lubricant reservoir is filled with

lubricant. Stop filling immediately when excess lubricant starts to emerge from the overflow outlet.



**Warning!**

When topping up, take care not to let lubricant emerge from the overfill outlet.  
Danger of accident or environmental pollution!

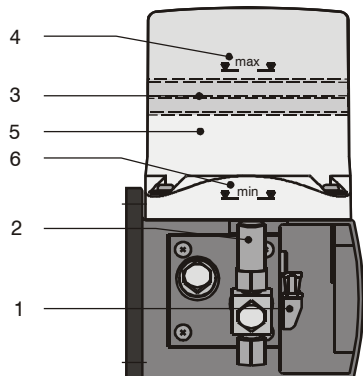

Fig.28. Side view

- 1 Conical head nipple
- 2 Pressure regulating valve
- 3 Follower piston
- 4 "max" mark
- 5 Lubricant
- 6 "min" mark

### 6.3. Vent centralized lubrication system



#### **Warning!**

The lubricant may only be fed without bubbles. Air pockets in the lubricant adversely affect the function of the piston pump unit and impair the reliability of lubricant delivery, which can result in damage to the lubrication points requiring lubrication.

- **Disconnect lubricant branch lines from master distributor. Operate the piston pump unit until bubble-free lubricant emerges from all ports of the master distributor. Reinstall the lubricant branch lines.**
- **Finally, vent the lubricant branch lines, secondary distributors, lubricant lines, and lubrication points, and check for proper functioning.**

The process of venting the centralized lubrication system can be facilitated by:

- Opening the ends of the main lubricant line until bubble-free lubricant discharges from the ends.
- Filling long lubricant line sections before connecting.

The centralized lubrication system is vented as follows:

- **Disconnect the main lubricant lines from the piston pump unit. Operate the piston pump until the lubricant emerging from the pressure regulating valve is free of bubbles. Reinstall the main lubricant lines.**
- **Disconnect main lubricant line from master distributor. Operate the piston pump until lubricant emerges free of bubbles. Reinstall the main lubricant lines.**

## 7. Electronic control unit

### 7.1. KFAS control unit (industrial and commercial vehicles)

#### 7.1.1. Display and control elements (KFAS)

The piston pump unit with reservoir is operated via a control screen (→ Fig.29). The display and control elements are explained in

→ Table18. → Table20 contains an overview of the display options of the three-digit LED display.

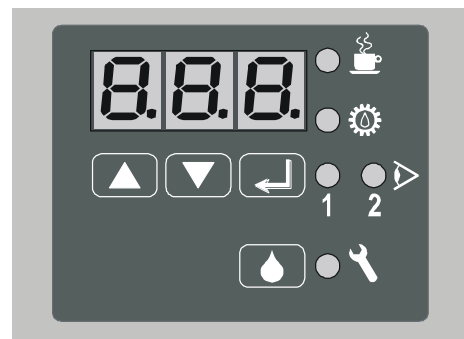

Fig.29. Display and control unit (KFAS)

The control screen is protected against splashwater and mechanical damage by a transparent plastic cover. In order to operate the piston pump unit, remove the cover using a screwdriver.

The layout of the control screen has changed since 2007. See → Table18 for a comparison of the

display and control elements of the new control screen with those of the old one.

Table 18. Display and control elements of control screen (KFAS)

Symbol		Description	Function
Old screen	New screen		
		Three-digit LED display	Displays parameters, values, conditions, and fault messages
		PAUSE LED	Indicates interval time
		CONTACT LED	Indicates contact time (pump operation)
		CS LED	Indicates progressive distributor monitoring using one cycle switch
		PS LED	No function on progressive systems
		FAULT LED	Indicates a fault
		UP or DOWN button	<ul style="list-style-type: none"> <li>○ Switch on display.</li> <li>○ Display parameters and values.</li> <li>○ Set parameters and values.</li> </ul>
		SET button	<ul style="list-style-type: none"> <li>○ Switch between programming mode and display mode.</li> <li>○ Select parameters and confirm values.</li> <li>○ Displays pending fault messages.</li> </ul>
		DK button	<ul style="list-style-type: none"> <li>○ Trigger interim lubrication.</li> <li>○ Clear fault message.</li> </ul>

### 7.1.2. Pushbutton operation (KFAS)

#### 7.1.2.1. Button (DK)

By pressing this button, the lubrication procedure is started with the programmed parameters independently of the current system status.

The control screen is not switched on, and any currently active display or programming mode is interrupted. At the same time, any pending fault messages are cleared.







Prior to clearing pending fault messages, first read them on the control screen to ensure smooth operation by determining and rectifying the cause of the fault.

#### 7.1.2.2. Button (UP)

A brief press of this button while the control screen is off activates display of current parameters and their values (display mode). Each additional brief press of this button causes the next value or parameter to be displayed. See → Table27 for the sequence of displays. After the last value has been shown, the control screen switches off again.

A brief press in programming mode calls the next parameter or increments the displayed value.

**Table 19. Pushbutton operation (KFAS)**

Button	Function	
	Brief press during the interval time: Brief press during fault:	Starts a lubrication procedure. Fault message is acknowledged and cleared.
	Brief press when screen is off: Brief press in display mode: Brief press in programming mode: displayed value by 1.	Activates display mode. Opens the next parameter or value. Opens the next parameter or increments the
	Brief press when screen is off: Brief press in programming mode: displayed value by 1.	Activates display mode. Opens the preceding parameter or decrements the
	Long press when screen is off: Brief press in programming mode: Long press (> 3 s) in programming mode:	Activates programming mode. Selects parameters and values and confirms them. Terminates programming mode.

#### 7.1.2.3. Button (DOWN)

Pressing the button while the control screen is off activates display of current values and parameters (display mode). The displays can then be consecutively called via the  button.

A brief press in programming mode calls the preceding parameter or decrements the displayed value.

#### 7.1.2.4. Button (SET)

A long press (> 3 s) while the screen is off activates programming mode. Any currently running lubrication procedure is then interrupted.

During programming, this button can be used to select and confirm parameters and values. Upon confirmation of a value, this value is immediately stored in the memory of the control unit.

A long press (> 3 s) during the programming mode terminates this mode and starts the programmed interval time of the lubrication cycle.

Table 20. Explanation of display contents of the three-digit LED display (KFAS)

Display	Explanation of characters	Explanation	Value range	Factory setting
t P A	t = timer PA = PAuse	"Interval time in timer mode" parameter The displayed value(s) refer(s) to the interval time of the lubrication cycle	0.1 h to 99.9 h	10 h
c P A	c = counter PA = PAuse	"Interval time in counter mode" parameter The displayed value(s) refer(s) to the interval time of the lubrication cycle	1 - 999 Pulses	-
t C O	t = timer CO = COntact	"Contact time in timer mode" parameter The displayed value(s) refer(s) to the contact time of the lubrication cycle	0.1 min – 99.9 min KFA...W.. designs min 0.6 min	configuration-dependent
c C O	c = counter CO = COntact	<b>Special application. Not applicable to the piston pump units with reservoir described in these instructions.</b>	-	-
C O P	C = Cycle O = OFF P = Pressure	"Monitoring function" parameter	CS - Progressive distributor monitoring using a cycle switch. PS - <b>Setting not permitted</b> OFF - Progressive distributor monitoring is deactivated.	OFF
C S	Cycle Switch	Value for "monitoring function" parameter Progressive distributor monitoring using one cycle switch.	-	-
P S	Pressure Switch	<b>Setting not permitted</b>	-	-
O F F	OFF	Value for "monitoring function" parameter Progressive distributor monitoring is deactivated.	-	-

Continued on next page

Continuation of Table 20. Explanation of display contents of the three-digit LED display (KFAS)

Display	Explanation of characters	Explanation	Value range	Factory setting
FCS	Fault Cycle Switch	"Cycle switch" fault message No signal from cycle switch during contact time.	-	-
FLL	Fault Low Level	"Fill level" fault message The level in the reservoir has fallen below the minimum fill level.	-	-
Oh	Operation hour meter	Operating hour meter The following figures indicate the operating hours of the control unit. Two display values appear: Display 1: The first three digits of the value. Display 2: The last two digits and one decimal place.	0.1 – 99999.9 hours not deletable	0 hours
Fh	Fault hour meter	Fault hour meter The following figures indicate the fault hours of the control unit. Two display values appear: Display 1: The first three digits of the value. Display 2: The last two digits and one decimal place.	0.1 – 99999.9 hours not deletable	0 hours
blo	block	Block mode No signal from cycle switch. Unlike in normal mode, the control unit is still in the monitoring sequence. A fault message is issued if the fault remains for three contact times.	-	-

### 7.1.3. Programming (KFAS)

#### 7.1.3.1. Starting programming mode (KFAS)







Programming mode can only be opened if the display is off.

Long press (> 3 s) the  button to switch on the screen and start programming mode.

When programming mode is activated, any currently active lubrication procedure is interrupted. After exiting programming mode, a new lubrication cycle is started with the current values and parameters if no fault message is present. The lubrication cycle starts with the interval time.

During programming, the PAUSE, CONTACT, or CS LEDs flash, depending on the parameters that are currently being adjusted.

**Table 21. Starting programming mode (KFAS)**









Step	Button	Action	Display
1		Press longer than 3 s.	 <p>000 is displayed. The three-digit LED display flashes.</p>
Step 2 follows if the factory-set programming code 000 has already been changed otherwise go straight to step 3.			
2	 	Press repeatedly until the current programming code is set.	 <p>The current programming code is displayed. <b>Example:</b> 666 The three-digit LED display flashes.</p>
3		Press briefly. (confirm code)	 <p>The first adjustable parameter is displayed. <b>Example:</b> Interval time in timer mode The PAUSE LED flashes.</p>

### 7.1.3.2. Set interval time and contact time (KFAS)

First activate programming mode (→ Table21). The interval time is displayed as the first adjustable parameter.

Set the interval time and the contact time as described in → Table22. Observe the value ranges in → Table20 or in the → Technical Data. The PAUSE or CONTACT LEDs will flash while you make the changes.









**Table 22. Set interval time and contact time (KFAS)**

Step	Button	Action	Display	
				Programming mode is active. The first adjustable parameter is displayed. <b>Example:</b> Interval time in timer mode The PAUSE LED flashes.
1		Press briefly. (select the parameter)		The current value for the interval time is displayed. <b>Example:</b> 24 h The PAUSE LED flashes.
2	 	Press repeatedly until the desired value is set.		The new value is displayed. <b>Example:</b> 36 h The PAUSE LED flashes.
3		Press briefly. (confirm the new value)		Display the next parameter. <b>Example:</b> Contact time in timer mode The CONTACT LED flashes.  The new value for the "interval time" parameter has been confirmed and stored in the control unit's non-volatile memory.

Continued on next page



Continuation of Table 22. Set interval time and contact time (KFAS)

Step	Button	Action	Display
4		Press briefly. (select the parameter)	 <p>The current value for the contact time is displayed. <b>Example:</b> 6,5 min (6 min 30 s) The CONTACT LED flashes.</p>
5	 	Press repeatedly until the desired value is set.	 <p>The new value is displayed. <b>Example:</b> 8 min The CONTACT LED flashes.</p>
6		Press briefly. (confirm the new value)	 <p>Display the next parameter. <b>Example:</b> Monitoring function The CS and PS LEDs flash.</p> <p>The new value for the "contact time" parameter has been confirmed and stored in the control unit's non-volatile memory.</p>
7		Press longer than 3 s.	<p>The display clears. A new lubrication cycle is started beginning with the interval time.</p>









### 7.1.3.3. Set monitoring functions (KFAS)

First activate programming mode (→ Table21).

Switch the monitoring function on or off as described in → Table23. Observe the value ranges in → Table20 or in the → Technical Data.

The CS or PS LEDs will flash while you make the changes.

**Table 23. Set monitoring functions (KFAS)**

Step	Button	Action	Display	
				Programming mode is active. The first adjustable parameter is displayed. <b>Example:</b> Interval time in timer mode The PAUSE LED flashes.
1		Press repeatedly until COP is displayed.		The "monitoring function" parameter is displayed. The type of progressive distributor monitoring can now be changed. The CS and PS LEDs flash.
2		Press briefly. (select the parameter)		The current value for the "monitoring function" parameter is displayed. <b>Example:</b> OFF (progressive distributor monitoring is off) The CS and PS LEDs flash.
3	 	Press repeatedly until the desired value is set.		The display changes between OFF, CS, and PS. OFF – Progressive distributor monitoring is deactivated. CS – Progressive distributor monitoring using one cycle switch is active. PS – <b>Setting not permitted</b> The CS and/or PS LEDs flash.
4		Press briefly. (confirm the new value)		The new setting has been confirmed and stored in the control unit's non-volatile memory.
5		Press longer than 3 s.		The display clears. A new lubrication cycle is started beginning with the interval time.







#### 7.1.3.4. Change mode of operation (KFAS)

First activate programming mode. (→ Table21).

Change the mode of operation as described in → Table24. Observe the information in → Chapter 3.5.1, "Modes of operation" as well as the value ranges in → Table20 and/or in the → Technical Data.











The PAUSE LED will flash while you make the changes.

**Table 24. Change mode of operation (KFAS)**

Step	Button	Action	Display
			 <p>Programming mode is active. The first adjustable parameter is displayed. <b>Example:</b> Interval time in timer mode The PAUSE LED flashes.</p>
1		Press briefly.	 <p>The display changes from tPA to cPA. tPA – Interval time in timer mode (values in hours) cPA – Interval time in counter mode (values in pulses) The PAUSE LED flashes.</p>
2		Press briefly. (confirm the new value)	 <p>Display the next parameter. <b>Example:</b> Contact time in timer mode The CONTACT LED flashes.</p> <p>The new value for the "interval time" parameter has been confirmed and stored in the control unit's non-volatile memory.</p>
<p>The change of the mode of operation is now complete. You can leave programming mode by long pressing (&gt; 3 s) .</p> <p>If desired, the duration of the interval time can also be set by entering the number of pulses.</p>			

Continued on next page

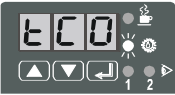
Continuation of Table 24. Change mode of operation (KFAS)

Step	Button	Action	Display	
3		Press briefly.		The display switches back to the "interval time in counter mode" parameter. The PAUSE LED flashes.
4		Press briefly. (select the parameter)		The current value for the interval time is displayed. <b>Example:</b> 24 pulses The PAUSE LED flashes.
5	 	Press repeatedly until the desired value is set.		The new value is displayed. <b>Example:</b> 36 pulses The PAUSE LED flashes.
6		Press briefly. (confirm the new value)		Display the next parameter. <b>Example:</b> Contact time in timer mode The CONTACT LED flashes.  The new value for the "interval time" parameter has been confirmed and stored in the control unit's non-volatile memory.
7		Press longer than 3 s.		The display clears. A new lubrication cycle is started beginning with the interval time.

### 7.1.3.5. Change programming code (KFAS)

The programming code prevents settings on the control unit from being adjusted accidentally. It must be entered in order to access programming mode.



Setting a new programming code deletes the factory default programming code and activates the new value. Write down the new value and store it in a safe place. The parameters cannot be programmed if the programming code is lost or forgotten. In this case, the piston pump unit must be sent to the dealer or authorized SKF branch office.



#### Warning!

Do not enter the digits 321 as the new programming code.

**Table 25. Change programming code (KFAS)**

Step	Button	Action	Display
1		Press longer than 3 s.	000 is displayed. The three-digit LED display flashes.
2	 	Press either until 321 is set.	The key code 321 is displayed. The three-digit LED display flashes.
3		Press briefly (confirm key code).	The display returns to 000. The three-digit LED display flashes.
If the programming code has already been changed, it must be entered again before making another change. Proceed with step 5 if you want to reprogram the code.			
4	 	Press either until the old code is set.	The old code is displayed. <b>Example:</b> 333 The three-digit LED display flashes.
5		Press briefly (confirm old code).	Display the factory setting 000 or the new code, <b>Example:</b> 333 The three-digit LED display flashes.
6	 	Press either until the new code is set.	The new code is displayed. <b>Example:</b> 666 The three-digit LED display flashes. <b>Warning! Do not enter 321.</b>
7		Press briefly (confirm new code).	The new value for the programming code has been confirmed and stored in the control unit's non-volatile memory.
8		Press longer than 3 s.	The display clears. A new lubrication cycle is started beginning with the interval time.







#### 7.1.4. Operation of KFAS (industrial and commercial vehicles)

##### 7.1.4.1. LED displays on the control screen during operation (KFAS)

During operation, you should regularly check the LED displays on the control unit's control screen (→ Table 26).

Further information about the operating state and the set parameters can be queried in display mode (→ next Chapter).

**Table 26. LED displays on the control screen during operation (KFAS)**

LED	LED lights up
	Operating voltage is present on the piston pump unit and the control unit. The centralized lubrication system is currently in the interval time.
	Operating voltage is present on the piston pump unit and the control unit. The centralized lubrication system is currently in the contact time.
	During the contact time: Progressive distributor monitoring using one cycle switch is active.
 2	Not assigned
	Fault The operational sequence has been stopped or the piston pump unit is currently in block mode (→ Chapter 3.5.6, "Block mode").  Additional information can be accessed by pressing  or  (→ Chapter 7.1.5, "KFAS fault indications").

#### 7.1.4.2. Display mode (KFAS)

During normal operation, the three-digit LED display is switched off and, depending on the operating state, only the PAUSE, CONTACT, CS, or FAULT LEDs light up (→ preceding Chapter).

To display the current operating parameters, the three-digit LED display is activated by briefly pressing one of the two buttons ▲ or ▼. The LED display is then in display mode.

In display mode, you can query the current parameters and their values one by one. The procedure is shown in → Table27.

















→ Table20 in Chapter 7.1.1, "Display and control elements (KFAS)" shows an overview of the possible display contents, their meaning and the value range.

**Table 27. Display of parameters in display mode (KFAS)**

Step	Button	Display	
1	▲ ▼ Press briefly.		Display mode is activated. The current operating state is displayed. <b>Example:</b> Interval time in timer mode
2	▲		Display of remaining interval time in the current lubrication cycle <b>Example:</b> 3.8 h If a lubrication procedure is currently being executed (CONTACT LED lights up), --- is displayed.
3	▲		Display of the programmed total interval time <b>Example:</b> 1 h
4	▲		Switchover to the "contact time" parameter. <b>Example:</b> Contact time in timer mode
5	▲		Display of the remaining contact time for current lubrication cycle <b>Example:</b> The centralized lubrication system is currently in the interval time; the remaining contact time therefore cannot be displayed.
6	▲		Display of the programmed contact time <b>Example:</b> 4 min
7	▲		Switchover to the "monitoring function" parameter.

Continued on next page

Continuation of Table 27. Display of parameters in display mode (KFAS)

Step	Button	Display
8		<p>Display of the monitoring function status.</p> <div style="display: flex; justify-content: space-around;"> <div style="text-align: center;">  <p><b>Example:</b> Progressive distributor monitoring is switched off.</p> </div> <div style="text-align: center;">  <p><b>or:</b> Progressive distributor monitoring using one cycle switch is active.</p> </div> </div>
9		<div style="display: flex; justify-content: space-around;"> <div style="text-align: center;">  </div> <div> <p>Operation hour meter The operation hours are displayed in two parts:</p> </div> </div>
10/11	 	<div style="display: flex; justify-content: space-around;"> <div style="text-align: center;">  <p><b>Example:</b> 1st part of total value</p> </div> <div style="text-align: center;">  <p>2nd part of total value</p> </div> </div> <p>Total value: 533.8 h</p>
12		<div style="display: flex; justify-content: space-around;"> <div style="text-align: center;">  </div> <div> <p>Fault hour meter The fault hours are displayed in two parts:</p> </div> </div>
13/14	 	<div style="display: flex; justify-content: space-around;"> <div style="text-align: center;">  <p><b>Example:</b> 1st part of total value</p> </div> <div style="text-align: center;">  <p>2nd part of total value</p> </div> </div> <p>Total value: 33.8 h</p>
15		The display clears.



### 7.1.5. KFAS fault indications

#### 7.1.5.1. Display of faults (KFAS)

When progressive distributor monitoring is active and depending on whether the piston pump unit is equipped with a fill level switch, the electronic control unit will display the malfunctions listed in → Table 28.

#### Fault indication

- o FAULT LED lights up.

#### Read fault message

The fault message can be read on the control screen in view mode:

- Briefly press  or  to activate display mode.
- Press  until a fault message is displayed.

Table 28. Fault messages (KFAS)

Display	Meaning
FCS	Fault Cycle Switch: No signal from cycle switch during contact time. The centralized lubrication system is currently in block mode (→ Chapter 3.5.6, "Block mode").
FLL	Fault Low Level: The minimum fill level in the lubricant reservoir has been reached. The operational sequence has been stopped.

#### 7.1.5.2. Delete fault messages (KFAS)

The fault messages are acknowledged and cleared by pressing the  button. At the same time, a new lubrication procedure is started.



#### Warning!

Prior to clearing a fault message, the cause of the fault must be determined and rectified.

#### 7.1.5.3. Fault hour meter (KFAS)

The time which has elapsed between the occurrence of the fault message and the rectification of the fault is stored in the non-volatile memory of the control unit as a fault hours figure.

When this is done, all fault state-times counted during the entire operating time of the piston pump unit are summed. The current count can be read as described in → Chapter 7.1.4.2, "Display mode (KFAS)."

The memory cannot be deleted.

## 8. Shutdown

### 8.1. Temporary shutdown

The described product can be temporarily shut down by disconnecting the electrical, pneumatic, and/or hydraulic supply connections. The instructions in → Chapter 1, "Safety instructions" in these owner's manual must be observed when doing so.

If the product is to be shut down for an extended period of time, follow the instructions in → Chapter 5, "Transport, delivery, and storage" in these owner's manual.

To recommission the product, follow the instructions in → Chapters 4, "Assembly instructions" und 6, "Operation" in these owner's manual.

### 8.2. Permanent shutdown

If the product will be permanently shut down, the local regulations and laws regarding the disposal of contaminated equipment must be observed.



#### Warning!

Lubricants can contaminate soil and bodies of water. Lubricants must be used and disposed of properly. Observe the local regulations and laws regarding the disposal of lubricants.

The product can also be returned to SKF Lubrication Systems Germany GmbH for disposal, in which case the customer is responsible for reimbursing the costs incurred.

## 9. Maintenance

### 9.1. General notes



#### **Danger!**

Performing work on an energized pump or product may result in serious injury or death. Assembly, maintenance, and repair work may only be performed on products that have been de-energized by qualified technical personnel. The supply voltage must be switched off before opening any of the product's components.



#### **Danger!**

Centralized lubrication systems are pressurized during operation. Centralized lubrication systems must therefore be depressurized before starting assembly, maintenance or repair work, or any system modifications or system repairs.



#### **Danger!**

The described product is pressurized during operation. The product must therefore be depressurized before starting assembly, maintenance or repair work, or any system modifications or system repairs.

Products from SKF Lubrication Systems Germany GmbH are low-maintenance. However, all connections and fittings must be regularly inspected for proper seating to ensure proper function and to prevent hazards from arising.

SKF Lubrication Systems Germany GmbH shall not be held liable for damages resulting from improperly performed assembly, maintenance or repair work on the product.

### 9.2. Cleaning

If necessary, the product can be cleaned using mild cleaning agents that are compatible with the product's materials (non-alkaline, non-soap). For safety reasons, the product should be disconnected from the power supply and the hydraulic and/or compressed air supply.

Do not allow any cleaning agent to enter the interior of the product during cleaning.

It is not necessary to clean the interior of the product if the product is operated normally and intercompatible lubricants are used.

The interior of the product must be cleaned if incorrect or contaminated lubricant is accidentally filled into the product. If this occurs, please contact the Service department of SKF Lubrication Systems Germany GmbH for assistance.



Dismantling of the product or individual parts thereof within the statutory warranty period is not permitted and voids any claims.

### 9.3. Replacing the pump element



Only original spare parts from SKF Lubrication Systems Germany GmbH may be used. Unauthorized alterations to products and the use of non-original spare parts and accessories are prohibited and nullify the statutory warranty.

Too little or no lubricant will be delivered if a pump element is worn out. After removing the main lubricant line and the pressure regulating valve, you can keep the outlet port of the pump element closed with a finger when the piston pump unit operates to deliver lubricant. This is a sign that the element is worn.

**Step 1:**

Unscrew pump element. If the piston of the pump element gets stuck in the lubricant present in the strainer ring, remove it with a suitable tool (→ Fig.30).

**Step 2:**

Remove bothersome lubricant between the internal thread, guide slot in the strainer ring and the groove between the cam disc and return disc with a suitable tool.



The pump elements are fitted only with O-ring 15.4x2.1 (1) without any additional sealing ring. (→ Fig.31).



Fig.30. Removing the piston

**Step 3:**

Pull piston of the new pump element as far as possible out of the element, and insert it along the guide slot of the strainer ring between the cam disc and return disc (→ Fig.32). If the pump element has not been correctly installed, it is not possible to tighten the thread.



The piston pump unit must be vented after replacement of the pump element.



Fig.31. Pump element with O-ring (item 1)

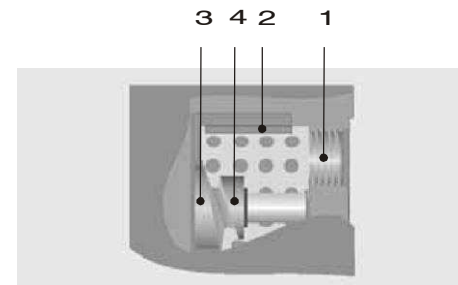

Fig.32. Sectional top view of pump housing

- 1 Internal thread
- 2 Guide slot in strainer ring
- 3 Cam disc
- 4 Return disc

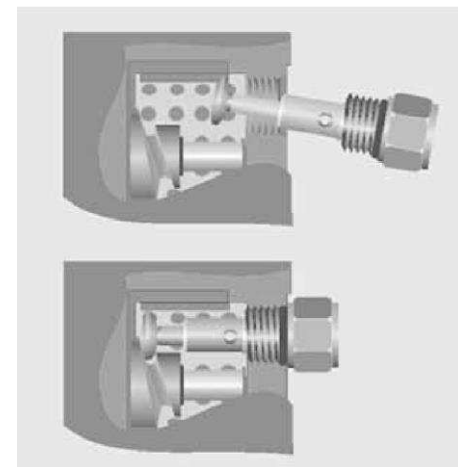

Fig.33. Inserting the pump element

## 10. Malfunctions

### 10.1. Fault indications on piston pump units without control unit

#### 10.1.1. Piston pump units without fill level monitoring (KFA..)

These piston pump units are not equipped with a display function for faults. Operational malfunctions can only be detected by external monitoring (visual or sensory).

#### 10.1.2. Piston pump units with integrated fill level monitoring (KFA..-W)

When using these piston pump units, an insufficient fill level in the lubricant reservoir is indicated by a signal issued via one of the electrical connectors. (→ Chapter 4.4, "Electrical connection")

### 10.2. Fault analysis and rectification

→ Table 29 provides an overview of possible malfunctions and their causes. Contact the Service department of SKF Lubrication Systems Germany GmbH if you cannot remedy the malfunction.

**Table 29** Fault analysis and rectification

Malfunction	Possible cause	Rectification
Electric motor does not start.	No operating voltage at the motor, pump blocked.	KFAS Check electrical connection.
Pump does not convey lubricant; no pressure build-up	Insufficient fill level.	Top up lubricant (→ Chapter 6.2, "Filling the lubricant reservoir"). Check fill level switch, if installed.
	Wrong lubricant, (→ Chapter 2 "Lubricants").	Replace lubricant in the entire centralized lubrication system; beforehand, remove all old lubricant and dispose of it properly.
	Air in the centralized lubrication system.	Vent centralized lubrication system. The lubricant must discharge without bubbles at the lubricant outlet (→ Chapter 6.3, "Vent centralized lubrication system").
During operation, the lubrication points are supplied insufficiently or not at all.	Metering volume too low.	Reduce interval time.
	Air in the centralized lubrication system.	Vent centralized lubrication system. The lubricant must discharge without bubbles at the lubricant outlet (→ Chapter 6.3, "Vent centralized lubrication system").
	Main lubricant line too long, cross-section too small (pressure regulating valve opens).	Check the lubricant transport through the main lubricant line and, if required, relocate the piston pump unit.
	Wrong lubricant, (→ Chapter 2 "Lubricants").	Replace lubricant in the entire centralized lubrication system; beforehand, remove all old lubricant and dispose of it properly.
	Lubrication line leaky.	Check connections.
	Piston pump unit worn out.	Replace entire piston pump unit.
	Progressive distributor defective.	Replace entire piston pump unit.

**Danger!**

Performing work on an energized pump or product may result in serious injury or death. Assembly, maintenance, and repair work may only be performed on products that have been de-energized by qualified technical personnel. The supply voltage must be switched off before opening any of the product's components.

**Danger!**

The hot surface of a motor may cause burns. Motor surfaces may only be touched with appropriate gloves or after the motor has been shut off for an extended time.

**Danger!**

Centralized lubrication systems are pressurized during operation. Centralized lubrication systems must therefore be depressurized before starting assembly, maintenance or repair work, or any system modifications or system repairs.



Dismantling of the product or individual parts thereof within the statutory warranty period is not permitted and voids any claims.

**Continuation of Table 29 Fault analysis and rectification**

Malfunction	Possible cause	Rectification
Excessive lubricant at all lubrication points.	Metering volume too high.	Increase the interval time.
Individual lubrication points are not supplied.	Lubrication line is clogged.	Clean lubrication lines.
	Lubrication line bent or broken.	Replace affected lubrication lines, insert filled lubrication lines.
	Distributor defective.	Replace entire piston pump unit.
Individual lubrication points receive insufficient or excessive lubrication.	Lubrication line too long.	Relocate the piston pump unit, shorten lubrication lines (max. 6 m).
	Metering volume too low or too high.	Connect the secondary feeder, if required, install a second pump unit with a reduced delivery rate to supply the second distributor. Supply lubrication points with lower lubrication requirements using the secondary distributor (2nd distributor) and lubrication points with higher lubrication requirements using the master distributor. In case of insufficient lubrication, reduce the interval time. In case of excessive lubrication, prolong it accordingly. Please contact SKF.



All assembly, maintenance and repair work beyond this scope must be performed by the Service department of SKF Lubrication Systems Germany GmbH .



Only original spare parts from SKF Lubrication Systems Germany GmbH may be used. Unauthorized alterations to products and the use of non-original spare parts and accessories are not permitted.

# 11. Technical data

**Table 30. Technical data**

Piston pump unit with reservoir	Unit	KFA1-(W)..., KFAS1-(W)..	KFA1-M-(W)..., KFAS1-M-(W)..	KFAS10-(W)	KFA10-(W)	Remark
<b>General</b>						
Delivery rate <sup>1)</sup>	cm <sup>3</sup> /min cm <sup>3</sup> /min	1.0; 1.5; 2.0	1.0; 1.5; 2.0	1.0; 1.5; 2.0	1.0; 1.5; 2.0 at 50 Hz 1.2; 1.8; 2.4 at 60 Hz	
Operating pressure	bar	max. 300	max. 300	max. 300	max. 300	
Number of outlets		max. 2	max. 2	max. 2	max. 2	
Ambient temperature	°C	-25 to +75	-25 to +75	-25 to +60	0 to +40	
Rated capacity of reservoir	liter	1	1	1	1	
Reservoir material		Plastic	Plastic	Plastic	Plastic	
Protection class		IP 6K9K	IP 55	IP 55	IP 55	
Grease NLGI Grade		up to 2	up to 2	up to 2	up to 2	
Flow pressure	mbar	max. 700	max. 700	max. 700	max. 700	
<b>AC motor</b>	Type	-	-	-	Split-pole motor	
Rated voltage	V AC	-	-	-	115 / 230	
Power consumption <sup>2)</sup>	A	-	-	-	115V: 1.54 / 1.08 (50/60 Hz)	
	A	-	-	-	230V: 0.77 / 0.54 (50/60 Hz)	
Rated frequency	Hz	-	-	-	50 / 60	
Mode of operation		-	-	-	S3 5% - 100 min	
<b>DC motor</b>	Type	Brushed motor	Brushed motor	Brushed motor	-	
Rated voltage	V DC	12 / 24	24	24	-	
Power consumption <sup>2)</sup>	A	1 / 0.5	0.5	-	-	
Mode of operation		S3 20% - 50 min	S3 20% - 50 min	S3 20% - 50 min	-	
<b>Switch-mode power supply, integrated</b>	V AC	none	none	yes	none	
Voltage, input	A	-	-	85 - 264	-	
Current, input	A	-	-	0.65 (115V)	-	
	A	-	-	0.4 (230V)	-	
	A	-	-	20 (115V)	-	
Current, inrush	A	-	-	40 (230V)	-	
	Hz	-	-	47 - 63	-	
Frequency, input		-	-	yes	-	
Overload protection		-	-	yes	-	
Overvoltage protection		-	-	yes	-	

Continuation of Table 30. Technical data

Piston pump unit with reservoir	Unit	KFA1-(W)... KFAS1-(W)..	KFA1-M-(W)... KFAS1-M-(W)..	KFAS10-(W)	KFA10-(W)	Remark
<b>Fill level switch</b>						
Function		NC contact	NC contact	NC contact	NC contact	
Rated voltage, max.	V DC	24	24	24	24	
Switched current, max.	A	0.5	0.5	0.5	0.5	
Switching capacity, max.	W	20	20	20	20	
<b>Control unit</b>	IG502-2-I with control unit and screen				none	
Interval time, adjustable (see "Mode of operation")	0.1...99.9 / 1...999 h / pulses (timer/counter mode) Factory setting: tPA = 10 h					
Contact time (pump cycle time), adjustable (see "Mode of operation")	0.1 ... 99.9 min KFA...W.. designs: min 0.6 min Factory setting:tCO = 2.0 min					
Operation hour meter	0.1 ... 99999.9 h (not deletable) Factory setting: 0.0 h					
Fault hour meter	0.1 ... 99999.9 h (not deletable) Factory setting: 0.0 h					
Monitoring of external cycle switches, adjustable	COP = CS (monitoring is active) COP = OFF (monitoring is inactive) Factory setting: COP = OFF					
Modes of operation	Counter or timer mode Factory setting: Timer operation					

<sup>1)</sup> With NGLI Grade 2 grease, back pressure p = 50 bar and ambient temperature T = 20 °C, depends on pump element (see → Table in → Chapter 3.2, "Pump elements")

<sup>2)</sup> With max. operating pressure p = 300 bar and ambient temperature T = 20°C



Blank page

Blank page

Blank page

Order number: 951-170-008

**Subject to changes in contents and technical information.**

Last modified: 19.07.2018

The contents of this publication are the copyright of the publisher and may not be reproduced in whole or in part without permission of SKF Lubrication Systems Germany GmbH . Every care has been taken to ensure the accuracy of the information contained in this publication. However, no liability can be accepted for any loss or damage whether direct, indirect or consequential, arising out of use of the information contained herein.

All SKF Lubrication Systems Germany GmbH products may be used only for their intended purpose as described in these owner's manual with associated operating instructions. If assembly/operating instructions are supplied together with the products, they must be read and followed.

Not all lubricants can be fed using centralized lubrication systems. SKF can, on request, inspect the suitability of the lubricants selected by the user for pumping in centralized lubrication systems. Lubrication systems and their components manufactured by SKF Lubrication Systems Germany GmbH are not approved for use in conjunction with gases, liquefied gases, pressurized gases in solution, vapors or such fluids whose vapor pressure exceeds normal atmospheric pressure (1013 mbar) by more than 0.5 bar at their maximum permissible temperature.

Hazardous materials of any kind, especially the materials classified as hazardous by CLP Regulation EC 1272/2008 may only be used to fill SKF centralized lubrication systems and components and delivered and/or distributed with the same after consulting with and receiving written approval from SKF.

**SKF Lubrication Systems Germany GmbH**

Plant Berlin  
Motzener Strasse 35/37  
12277 Berlin  
Germany  
Tel. +49 (0)30 72002-0  
Fax +49 (0)30 72002-111

Plant Hockenheim  
2. Industriestrasse 4  
68766 Hockenheim  
Germany  
Tel. +49 (0)62 05 27-0  
Fax +49 (0)62 05 27-101

lubrication-germany@skf.com  
www.skf.com/lubrication

© SKF is a registered trademark of the SKF Group.  
© SKF Group 2018

